

How to Fake the Symptoms of Coronavirus:
A CIA Handbook

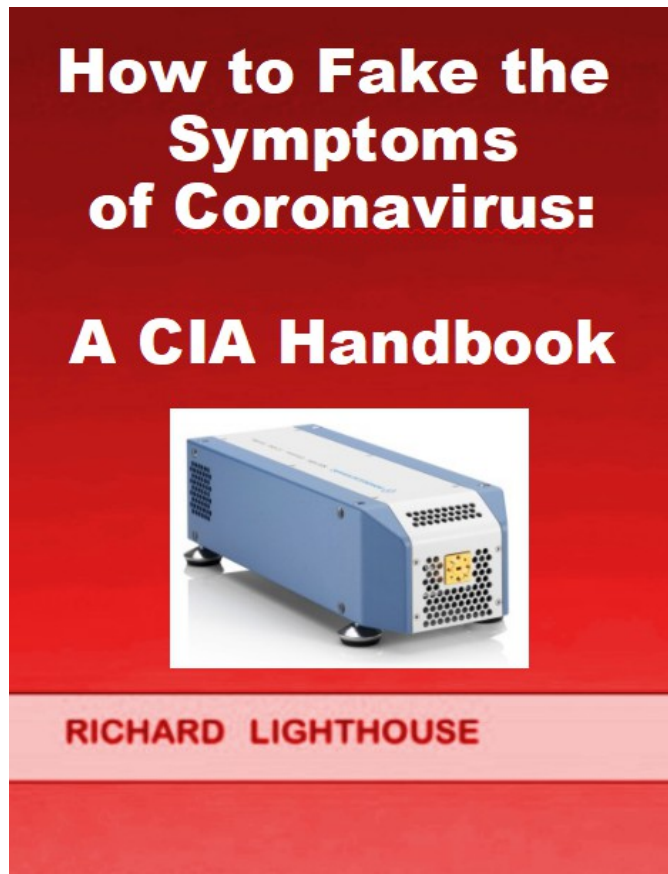

Richard Lighthouse

How to Fake the Symptoms of Coronavirus: A CIA Handbook

Published by Richard Lighthouse
Creative Commons 4.0 License, 2020 by Richard Lighthouse.
Please acknowledge source.



ISBN: 978xxxx

RLighthouse.com

Limit of Liability/Disclaimer of Warranty: While the author has used his best efforts in preparing this document, he makes no representations or warranties with respect to the accuracy or completeness of the contents and specifically disclaims any implied warranties or fitness for a particular purpose. Readers are encouraged to do their own research.

Contains opinions of the author. Opinions are a form of protected speech. See the Supreme Court case, Brandenburg v. Ohio.

6 October 2020

Rev 1B

Houston, Texas, U.S.A.

Original – 29 Sept 2020, Rev1A

TABLE OF CONTENTS

[Introduction](#)

[Conclusions](#)

[References](#)

Abstract

This short ebook presents one of the methods being used by the CIA to attack and murder thousands of victims in nursing homes. The deaths are blamed on Coronavirus. These same methods are also used to torture Targeted Individuals. I have compared the lung attacks to waterboarding, without the water, however the effect is the same – suffocation. The CIA criminals are also using microwave weapons to attack the throat – which can cause incessant coughing. The symptoms can lead many to believe that someone has contracted the coronavirus, which is not correct.

1. Introduction

Satellite tracking and cell towers are both involved in the technology to attack and murder thousands of people in nursing homes. The technology is sophisticated and the microwaves are invisible.

Figure 1. Targeted Individuals refer to these attacks as the “machine gun,” due to the rapid, high intensity microwave pulse. The attacks generally are directed thru a cell tower antenna using digital beamforming. Once the initial “raw spot” is created inside the throat, the coughing reflex can be turned on instantly, just like a light switch.

Fig. 1
Five attack points used to create coughing.

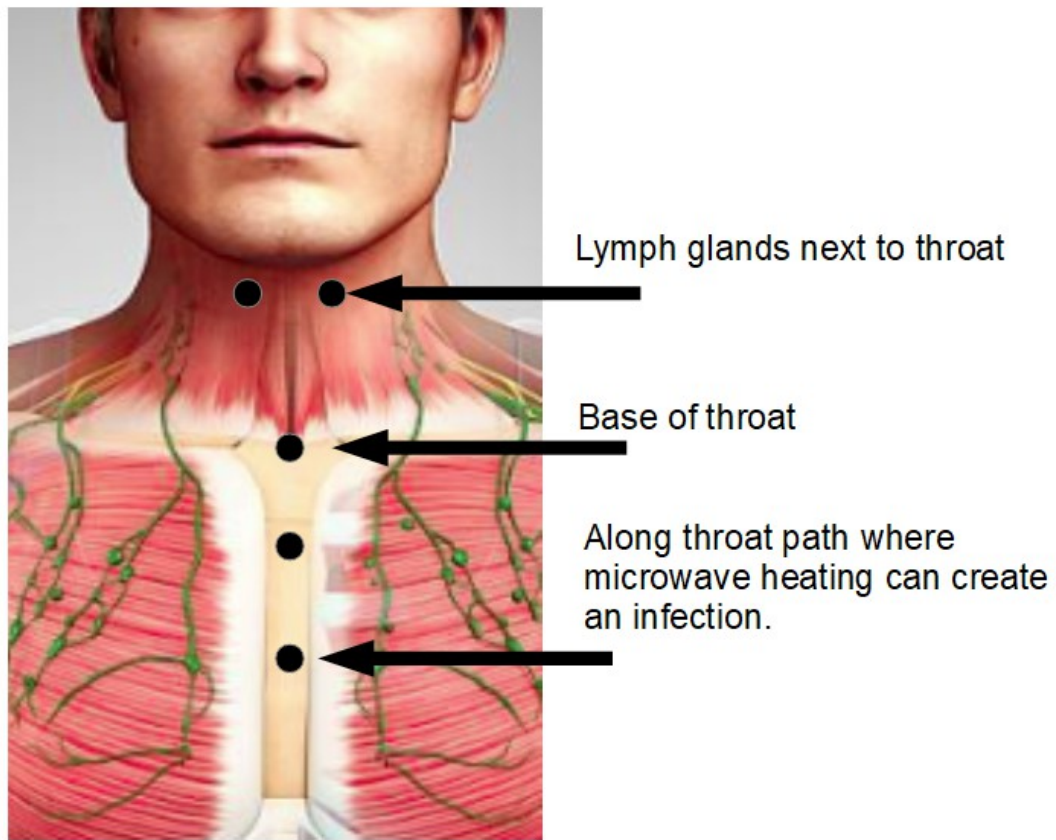
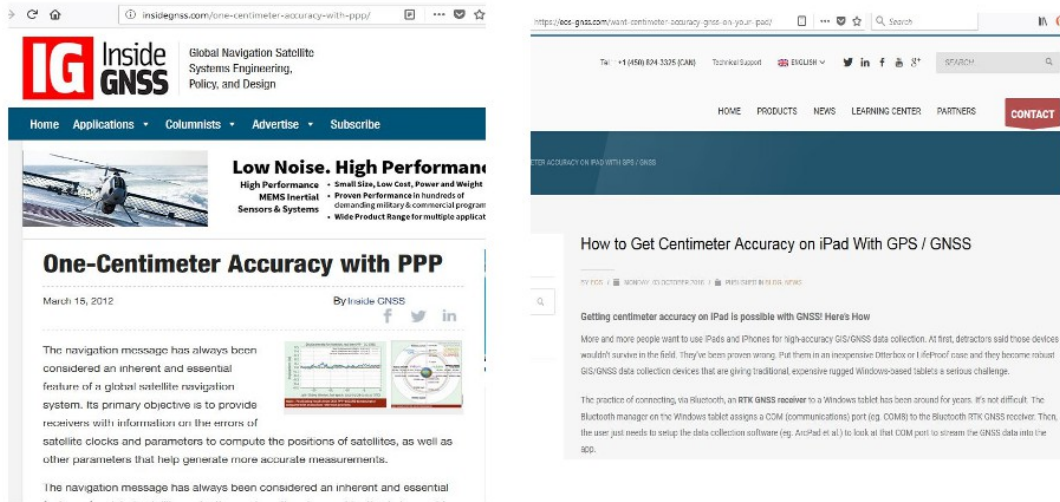

Figure 2. Five attack points to force coughing. Targeted Individuals refer to it as the “machine gun”, because it consists of a rapid microwave pulses.

Fig. 2
How accurate is the microwave beam ?



The accuracy is less than 1 centimeter (1/2 inch).

This technology is not new – it is 30 years old. Anyone can purchase it for their iPad. See these ads from GNSS magazine.

How to suffocate a victim:



Figure 3. Rohde & Swartz SZU100A. This is a murder weapon. It operates at 58 to 63 GHz. When the 60 GHz frequency is pointed at the lungs, it blocks the uptake of oxygen in the lungs, causing the victim to suffocate to death. The death is blamed on the coronavirus.

This is one example of the favorite murder weapons of the CIA right now. It is called a Signal Generator Upconverter - Rohde & Schwarz Model # SZU100A. Tens of thousands of people in U.S. nursing homes, are being murdered with this technology. It is about the size of a shoebox, and mounted in a cell tower. Rohde & Schwarz openly advertise that their equipment is used with 5G cell towers. The company is headquartered in Munich, Germany and has USA headquarters in Columbia, MD. Only a handful of companies in the world can make signal generators that reach these frequencies, so they are quite expensive - about \$50,000 for the basic equipment. It requires an input signal around 30 GHz, which is another expensive signal generator.

Note that it is very unusual to make a signal generator with such a limited frequency range. It is designed for one purpose - for use as a weapon.
www.Rohde-Schwarz.com

The 60 GHz signal can be directed from a cell tower using "digital beam forming," and it blocks the uptake of oxygen in the lungs and the patient suffocates to death. The death is blamed on Coronavirus. A NYC medical doctor discovered this, and posted a video on YouTube:
New York Medical Doctor, Cameron Kyle-Sidell, says many hospital patients are suffocating (hypoxia) - and it is not Coronavirus. It is evident that 5G microwaves (60 GHz) are being used to attack the lungs and block the uptake of oxygen. The patient suffocates to death and it is blamed on COVID. <https://youtu.be/k9GYTc53r2o>

Professor Martin Pall, PhD, Washington State University:
<https://electromagnetichealth.org/electromagnetic-health-blog/5g-covid-19-epidemic/>

Oxygen Absorption signals can be measured using a Spectrum Analyzer:
<https://www.sciencedirect.com/science/article/abs/pii/S0022407311001099>

I have personally been attacked with these 60GHz weapons. You can feel the vibrations on your chest and back, and it causes great difficulty breathing, gasping for oxygen. It is the equivalent of waterboarding torture, except with air.



Latest in 5G at Rohde & Schwarz



Driven by connection

Rohde & Schwarz MWC2020 video series

Since MWC2020 in Barcelona does not take place, Rohde & Schwarz will bring their latest T&M innovations for 5G devices, base stations, 5G mobile networks, networking and firewall solutions and much more to you now.

Discover our innovative 5G test solutions in a compelling series of application videos, with topics ranging from 5G multichannel MIMO testing for FR1 to 5G NSA signaling testing for FR2.

[→ More information](#)

Born to enable 5G

The next generation of 5G NR test solutions

Testing 5G NR products requires innovative test and measurement approaches. Discover the new 5G testers from Rohde & Schwarz, perfected for 5G measurements in development, QM acceptance testing and production.



Figure 4. Rohde & Swartz specializes in 5G technologies. Screen capture taken in Sept 2020.

3:51 AM Tue Aug 18 rohde-schwarz.com LTE 88%

ROHDE & SCHWARZ

Home **Signal Generators** Cha

History R&S®SZU100A IQ Upconverter | Signal Generators

R&S®SZU100A IQ Upconverter

Overview Options Features & Benefits



Key facts [Expand](#)

- Upconversion of R&S®SMW200A generated signals to mmWave frequencies
- Flat frequency response independent of set level and frequency
- Fully characterized in factory; no need for external frequency response correction prior to measurements

Brief description [Expand](#)

The R&S®SZU100A IQ upconverter extends the R&S®SMW200A vector signal generator into the mmWave range.

Specifications [Expand](#)

Frequency Range	58.32 GHz to 64.80 GHz ± 1% occupied modulation bandwidth
RF modulation bandwidth	2GHz
Specified level range	-80 dBm to +5 dBm (PEP)

Quick Links

- R&S®SMW200A Vector Signal Generator

Conta

Down

- Broc
- Man
- Appl
- Doc

Relat

- R&S Gen

Figure 5. Model SZU100A specifications. Screen capture taken in Sept 2020. Note the frequency range of 58 to 64 GHz.

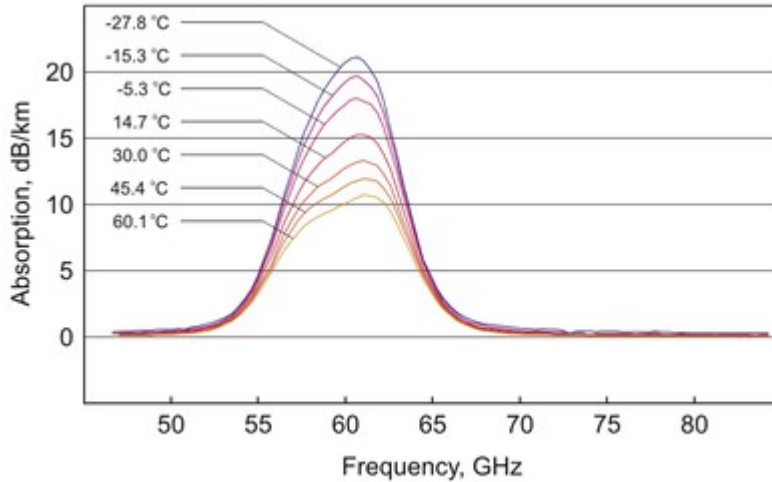
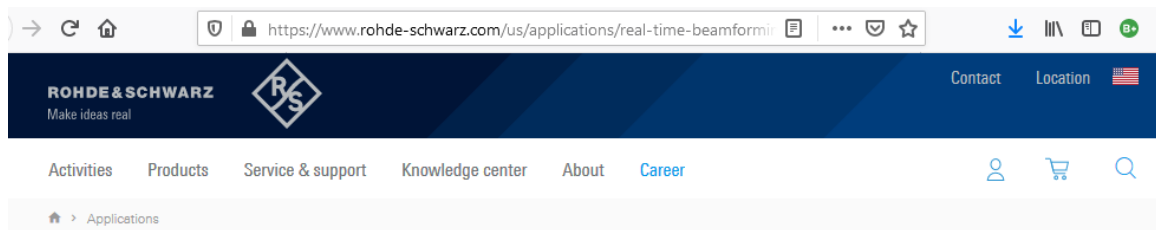

Fig. 2. Absorption profiles in air at several temperatures.

Figure 6. Oxygen absorption chart. Oxygen absorption at 60 GHz. Older patients are being murdered in nursing homes. 5G Microwave weapons are pointed at the lungs, blocking the absorption of oxygen. The patient suffocates to death and it is blamed on COVID.



Real-time beamforming verification in 5G NR FR1

During development of MU-MIMO antenna arrays, the beamforming algorithms undergo steady revision. Whether used in regression testing or verification of newly introduced features, fast beamforming verification helps to speed up R&D for beamforming antennas and improve performance of your product.

Figure 7. Digital Beamforming technology is used to precisely direct the 60 GHz signal at the lungs of the victim. The Chinese company Huawei has learned how to use digital beamforming. This is the real reason that the CIA and the Deep State are opposed to Huawei.

Satellite weapons can also be used. The USAF first patented the Vircator back in the 1980's. U.S. Patent 4345220. The Vircator can be mounted on a satellite and precisely aimed within 1/2 inch of any target on the ground. Targeted

Individual, Norman C. Rabin of Plainview, NY, has been attacked with DEW satellite weapons for 34 years, starting in Dec 1985. His court case filed in the 1990's, is one of the earliest, well-documented Targeted Individual cases.

US Patent 4345220, Submitted Feb. 12, 1980 for the Vircator Microwave Weapon.

<https://en.wikipedia.org/wiki/Vircator>

Donald J Sullivan
9100 Hagerman Ave NE (last known address)
Albuquerque, NM 87109

3) Patent 4345220 Granted to Donald J. Sullivan: Aug. 17, 1982
- Patent then assigned to U.S. Air Force.

File: Patent 4345220



us4345220.pdf

[Download File](#)

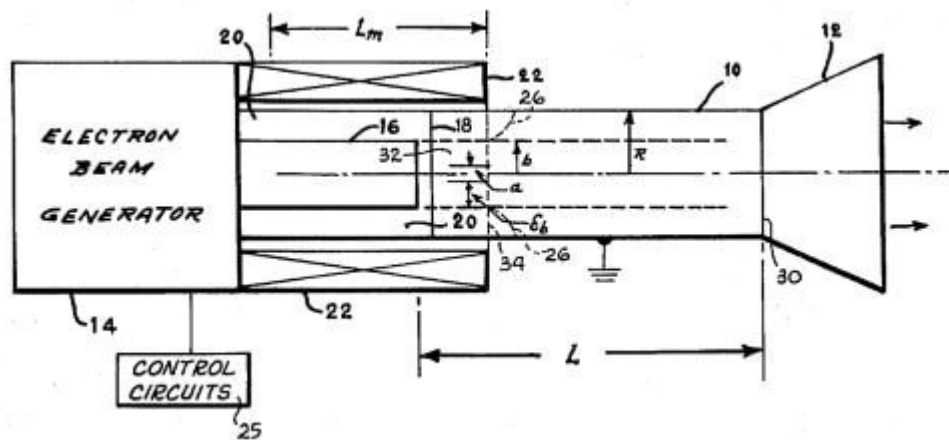

Figure 8. Vircator microwave weapon is mounted on a satellite, and emits a beam that is about 1/2 inch in diameter. The beam travels at the speed of light, and is invisible, just like the microwaves in your oven.

The Titan Corporation in San Leandro, California (acquired by L3Harris) admits that they built many of these High Power Microwave (HPM) units for the USAF.

DEW TECHNOLOGY AT THE TITAN CORPORATION

David Price, Edward Goldman, David Nett, Sidney Putnam, Doug Weidenheimer
Titan – Pulse Sciences Division, San Leandro, CA
Carl Bloemker, Titan Electromagnetics & Electronics Division, Albuquerque
Roger White, Titan – Pulse Sciences Division, San Diego, CA
Tony Wynn, Titan - Pulse Sciences Division, Watsonville, CA

ABSTRACT

The Titan Corporation has been developing directed energy technologies since the early 1980's. Over this time Titan has provided advanced power supplies for electromagnetic gun and laser research while making broader contributions in the field of high power microwaves (HPM). Titan's HPM work expanded from initial efforts fielding and operating the first gigawatt-level oscillators for susceptibility test applications, to research and development maximizing the peak and average output powers and overall efficiency realized from such systems. As interest in HPM technology has spread globally, Titan has leveraged this core competency and provided the HPM equipment for nearly all of the major European effects test facilities. Titan's current interests focus on compact, efficient and reliable directed energy weapon systems, and the advanced subsystems and components that enable the same. Specific subsystems of interest include pulse forming networks, intermediate energy storage and power conditioning elements. These subsystems are designed for reduced size and weight while still meeting severe service, platform integration, lifetime and thermal management constraints. Specific components under development at Titan include laser-gated solid-state switches and both high peak and high average power, frequency-agile, HPM oscillators. Status and recent results from this research are presented.

INTRODUCTION AND PREVIOUS WORK

Directed energy weapons (DEWs) are emerging as a key defense technology of the early 21st Century. The first laser anti-missile and anti-artillery systems are within perhaps five years of deployment, and newly envisioned information warfare and non-lethal point defense missions are hastening the deployment of high power microwave systems. Department of Defense (DoD) programs in "more electric" and "all-electric" platforms and electrically driven weapons and systems

and multiple threat types thereby fitting very well into this paradigm.

The initiatory HPM programs in the USSR and USA have evolved and influenced foreign allies and threats to take an interest. Major programs are in the USA and China; medium scale programs in the UK, France, Germany, and Russia; and emerging programs in Sweden, Japan, India, Taiwan, Australia, Israel and Korea. The collapse of the USSR has led to the dispersal of Russian and Ukrainian HPM workers and the proliferation of the Soviet technology to the Third World. This global emergence is driven by at least two factors: (1) increasing dependence of both military systems and civilian support infrastructure on sensitive electronics, and (2) after more than a twenty-year effort, maturing understanding of the susceptibilities of military and commercial systems to HPM threats.

For these reasons the Titan Corporation has taken a keen interest in the development of systems, subsystems and advanced components across several different technologies to support HPM and laser directed energy programs.

In 1997, Maxwell Technologies purchased Physics International (PI) from Primex Technologies and merged two of the three most prominent, commercial, pulsed power entities in the USA. Physics International and Maxwell pulsed power capabilities were combined into a new entity, Maxwell Physics International, which became a component of Maxwell's Systems Division. Maxwell subsequently decided to leave the DoD and DOE pulsed power business altogether and sold the combined Maxwell/PI pulsed power divisions to the Titan Corporation, the parent company of Pulse Sciences Incorporated (PSI). Now, the three most prominent commercial names in pulsed power are combined as the Pulse Sciences Division (Titan-PSD) of the Titan Corporation.

In March of 2002, Titan completed the acquisition of

Figure 9. "DEW Technology at the Titan Corporation." This technical paper is an admission that the Titan Corporation built these weapons under contract for the USAF. The document can be downloaded here - <https://www.targetedjustice.com/timeline-for-satellite-weapons.html>

2. Conclusions

Presented here are some of the technologies that are being used by the CIA to murder thousands of innocent civilians. These technologies are also being used

to torture Targeted Individuals.

This is a living document. The author reserves the right to make corrections and changes.

3. References

1. www.Rhode-Schwartz.com
2. New York Medical Doctor, Cameron Kyle-Sidell, says many hospital patients are suffocating (hypoxia) - and it is not Coronavirus. <https://youtu.be/k9GYTc53r2o>
3. Professor Martin Pall, PhD, Washington State University:
<https://electromagnetichealth.org/electromagnetic-health-blog/5g-covid-19-epidemic/>
4. Oxygen Absorption signals can be measured using a Spectrum Analyzer:
<https://www.sciencedirect.com/science/article/abs/pii/S0022407311001099>
5. 23 minute video - Introduction to Targeted Individuals & Neuroweapons (2019).
<https://www.youtube.com/watch?v=tAPI6mv2O-U>
Dr John Hall speaks at 18:45
6. Nurses file lawsuit against Athens hospital for falsifying COVID-19 test results
https://www.redandblack.com/athensnews/nurses-file-lawsuit-against-athens-hospital-for-falsifying-covid-19-test-results/article_6f5ce7c0-b2a6-11ea-8177-e773c881a160.html
7. RLighthouse.com
8. TargetedJustice.com

Acknowledgments

About: The author holds a Master of Science (M.Sc.) degree in Mechanical Engineering from Stanford University.

Contact:
RLighthouse -at-- protonmail.com

Funding:
This research was generously supported with a grant from the Foundation Opposed to Academic Puffery (FOAP).

APPENDIX

Figure 33. ISBN number